

INDUDRALL

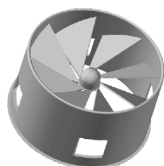

ELEMENTS

Type 1



Type 2



INDUDRALL diffusers allow wall air to be distributed with high induction when there are high endogenous loads, even when there is no false ceiling, thanks to the use of special micro spot diffusers of two different types (type 1 - type 2) appropriately matched based on the model and length of the diffusers. It allows ceiling returns to be achieved without creating "short circuits" in the air flows. Plate-mounted diffusers size 595 x 595 mm. Distribution plenum with side fitting.

MATERIAL AND FINISH

- Diffuser, both supply and return, in painted steel white RAL9010
- Diffuser finish in RAL colours (UPON REQUEST)
- Circular section micro spot diffusers in gray plastic
- Micro spot diffusers available in black (similar to RAL9005) or white (similar to RAL9010) (UPON REQUEST).

APPLICATION

- Suitable for both VAV and CAV systems, with flow rates varying from 100% to 20% with changes to jet behaviour
- Temperature difference during summer operation $\Delta T -12K$ and during winter operation of maximum $\Delta T +10K$
- The self-supporting air throw of this particular diffuser prevent sudden drops of the air, guarantees an air induction rate of 1:25 and keeps the residual velocity in the occupied area uniform as the flow rate changes. Furthermore, since the ceiling effect is not used, it prevents it from becoming dirty near the diffuser
- Installation height between 2.4 and 7.5 m.

FASTENING

Diffuser plate fastened to distribution plenum by central screw on bracket. Plenum supplied with four slots for hanging from the ceiling by tie rods or cables

- V and KQ diffuser can be fastened to the plenum with 4 screws (UPON REQUEST)
- KR diffuser can be fastened to the plenum with 3 screws (UPON REQUEST).

VERSIONS

Supply

- V diffuser with square diffusion plate, diffusion elements arranged in a square, micro spot diffusers in two different distribution types (Type 1 - Type 2)
- KR and KQ diffuser with square or circular diffusion plate, diffusion elements arranged in a circle, micro spot diffusers in two different distribution types (Type 1 - Type 2).

OPTIONS

- The models 300-400-500 are also available for size 595x595 mm.

ACCESSORIES

- Regulating damper with command from room
- Polyethylene C1 6 mm internal insulation
- External insulation (UPON REQUEST).

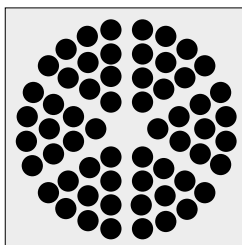

INDUDRALL KQ

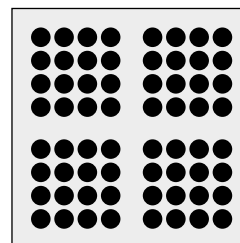

INDUDRALL V

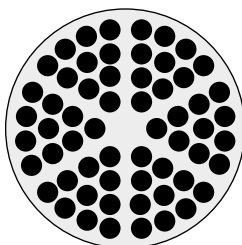

INDUDRALL KR

INDUDRALL

DIMENSIONS

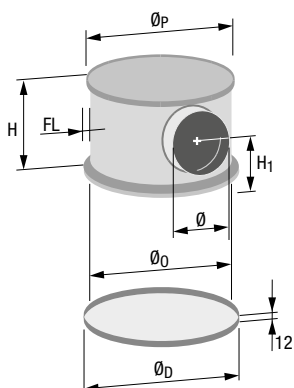
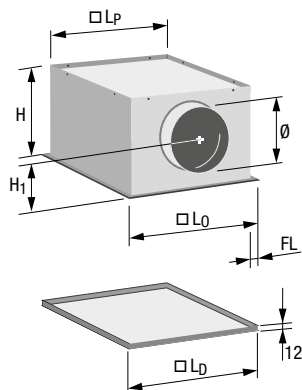

INDUDRALL KQ and V

Model	Dimensions [mm]						
	□L _D	□L ₀	□L _P	Ø	H	H ₁	FL
300	298	294	270	124	210	122	12
400	398	394	370	159	245	140	12
500	498	494	470	199	285	160	12
600	595	590	570	249	335	185	10
625	623	590	570	249	335	185	10
800	798	794	770	249	335	185	12

For false ceiling

300 / 600	595	590	570	124	210	122	10
400 / 600	595	590	570	159	245	140	10
500 / 600	595	590	570	199	285	160	10

INDUDRALL KR

Model	Dimensions [mm]						
	Ø _D	Ø ₀	Ø _P	Ø	H	H ₁	FL
300	300	294	270	124	210	122	12
400	400	394	370	159	245	140	12
500	500	494	470	199	285	160	12
600	600	590	570	249	335	185	10
625	625	590	570	249	335	185	10
800	800	794	770	249	335	185	12

FASTENING

INDUDRALL ceiling diffusers are set for central fastening by means of a screw in the front panel, equipped with screw cap.

For sizes 600-625-800 a support brace is provided to increase the diffuser's mechanical resistance.

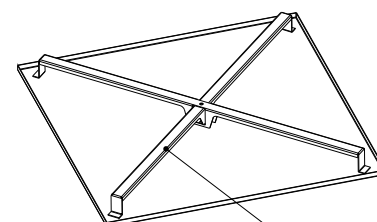

Support brace

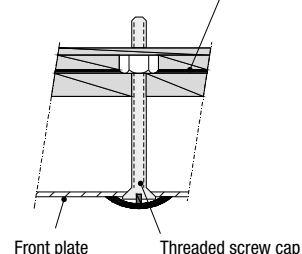

Front plate

Threaded screw cap

INDUDRALL

QUICK SELECTION

KR - KQ - V series	Q _{min}	Q ₃₅	Q _{max}
Pressure drop [Pa]	< 5	5	15
Noise level L _{WA} [dB(A)]	< 25	35	45

Q₃₅: air flow value necessary to guarantee the sound power level L_W shown below

