

INDULCLIP ZA INDUDRALL ZA

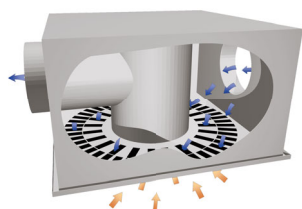

The high induction diffusers INDULCLIP ZA and INDUDRALL ZA provide air distribution and return with a single element.

By using the external part of the unit, the supply air section introduces air even with temperature differences of -10K and high air flow rates.

By using the central part of the unit, the return air is conveyed through a section inside the plenum to the return circuit.

Inlet at high induction when there are high endogenous loads, even when there is no false ceiling, thanks to the use of special micro spot diffusers of two different types, CLIP and DRALL.

Plate-mounted diffusers size 598 x 598 mm.

Distribution plenum with double side fittings for supply and return.

Polyethylene C1 6 mm internal insulation for the inlet section (external sides).

MATERIAL AND FINISH

- Diffuser plate made in painted steel white RAL9010
- Diffuser finish in different RAL colours (UPON REQUEST)
- Inlet section with black plastic micro spot diffusers
- Micro spot diffusers also available in grey (similar to RAL7035) or white (similar to RAL9010) (UPON REQUEST)
- Return section with square black mesh panel.

APPLICATION

- For systems where low returns are not possible
- Suitable for both VAV and CAV systems
- Installation height between 2.4 and 7.5 m
- Temperature difference during summer operation ΔT -10K and during winter operation of maximum ΔT +10K.

FASTENING

Diffuser plate fastened to distribution plenum by 4 external screws.

Plenum supplied with four slots for hanging from the ceiling by tie rods or cables.

VERSIONS

- **INDULCLIP ZA** with CLIP series micro spot diffusers with square diffusion plate. Diffusion elements arranged in a spoke. Micro spot diffusers in two different distribution types (P20W - C20)
- **INDUDRALL ZA** with DRALL series micro spot diffusers with square diffusion plate. Diffusion elements arranged in a square. Micro spot spot diffusers in two different distribution types (Type 1 - Type 2).

ACCESSORIES

- External insulation (UPON REQUEST).

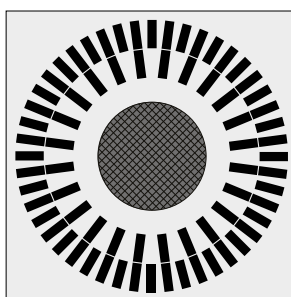

INDULCLIP ZA
CLIP ELEMENTS

C20

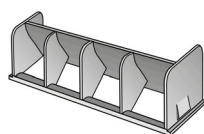

P20W

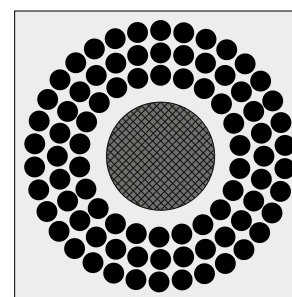
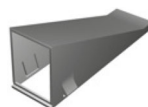

INDUDRALL ZA
DRALL ELEMENTS

Type 1

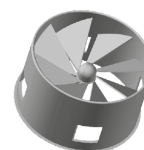

Type 2

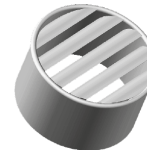

INDULCLIP ZA INDUDRALL ZA

DIMENSIONS

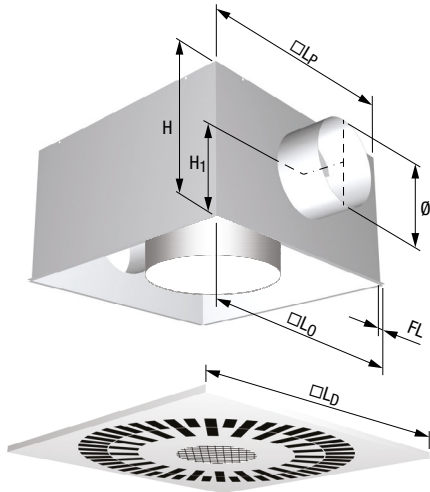

Model	Dimensions [mm]						
	□LD	□L0	□Lp	Ø*	H	H1	FL
600	598	594	570	198	335	185	12
625	623	594	570	198	335	185	12

* supply or return air connections diameter

QUICK SELECTION

	Q _{min}	Q ₃₅	Q _{max}
Supply pressure drop [Pa]	5	26	57
Return pressure drop [Pa]	< 15	35	45
Noise level L _{WA} [dB(A)]	< 15	35	45

Q₃₅: air flow value necessary to guarantee the sound power level L_W shown below

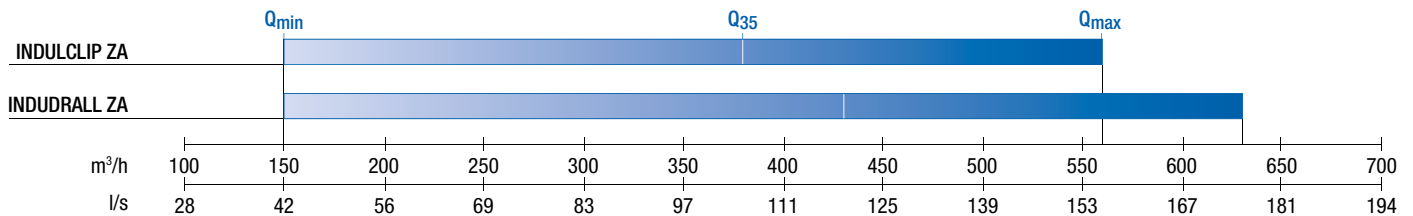

FASTENING

